

MOBILE ROOM AIR CONDITIONER

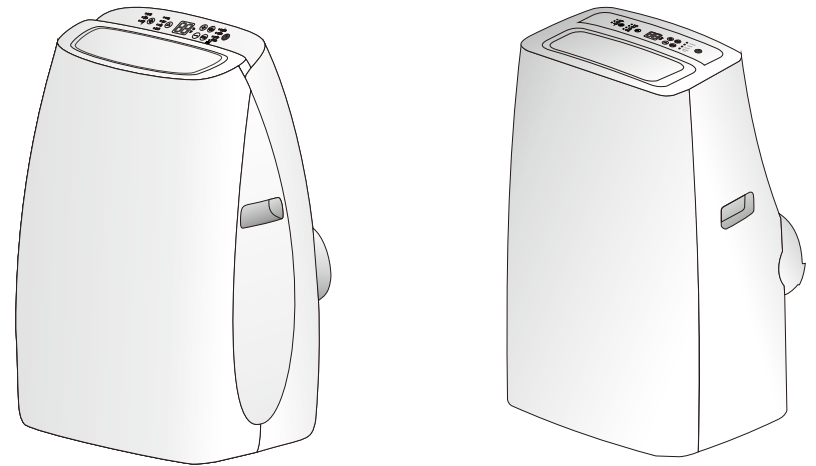

AUX AIR CONDITIONER CO.,LTD.

1166 North Mingguang Road, Jiangshan, Yinzhou, Ningbo, 315191
Zhejiang, China

FOR FUTURE REFERENCE

Safety Precaution	1
Parts Description	4
Control Panel.....	5
Operation.....	6
Accessories.....	7
Installation	9
Maintenance	12
Troubleshooting	13

Note: All the pictures in this manual are just schematic diagrams, the actual is the standard.

To save the cost of a service call, please try the suggestions below to see if you can solve your problem without outside help.

Air Condition Will Not Operate	
Causes	Solutions
<ul style="list-style-type: none"> ● The power switch is released. ● Power supply failure. ● The fuse is burnt. ● It doesn't reach the setting time for starting up. 	<ul style="list-style-type: none"> ■ Switch on the power. ■ Wait for the recovery of power supply. ■ Replace the fuse. ■ Wait or eliminate the original setting.

Unit Doesn't Start When Pressing ON/OFF Button	
Causes	Solutions
<ul style="list-style-type: none"> ● It is not four minutes after switch off. ● Room temperature is lower than the setting temperature under cooling mode or higher than setting temperature under heating mode. 	<ul style="list-style-type: none"> ■ Wait four minutes. ■ Reset the setting temperature.

The Wind Blowing Out, But The Cooling Effect Is Bad	
Causes	Solutions
<ul style="list-style-type: none"> ● Mistakes in temperature setting. ● The air filter is blocked by dust. ● The air inlet or outlet of machine is blocked. ● Turn the air conditioner on in very hot room. ● Cooling capacity is insufficient. ● The doors or windows are open. 	<ul style="list-style-type: none"> ■ Set a proper temperature, setting temperature should be lower than ambient temperature. ■ Clean the air filter. ■ Remove the obstruction. ■ Allow additional time to remove stored heat from walls ,ceiling, floor and furniture. ■ Reconfirm the required cooling capacity with your dealer. ■ Close the doors and windows.

Noise or vibration	
Causes	Solutions
<ul style="list-style-type: none"> ● The ground is not level or not flat enough. 	<ul style="list-style-type: none"> ■ Place the unit on a flat, level ground if possible.

WARNING

- ※ Before the cleaning of the air conditioner, it must be shut down and the electricity must be cut off for more than 5 minutes, otherwise there might be the risk of electric shocks.
- ※ Do not use gasoline, benzene, thinner or any other chemicals, or any liquid insecticide on the air conditioner, as these substances may cause flaking off of the paint, cracking or deformation of plastic parts .
- ※ Never attempt to clean the unit by pouring water directly over any of the surface areas, as this will cause deterioration of electrical components and wiring insulation.

Clean the unit

When the unit is contaminated, clean it gently with a wrung towel using tepid water below 40°C(104°F).



Clean the Air Filter

1. Remove the air filter

Respectively draw back the upper air intake grille and the lower air intake grille, take out the upper air filter 1 and the lower air filter 2 .

Note: There are two types about the low air intake grille, please refer to Fig. 1 or Fig. 2. If the low air intake with a screw, please remove the screw at first.

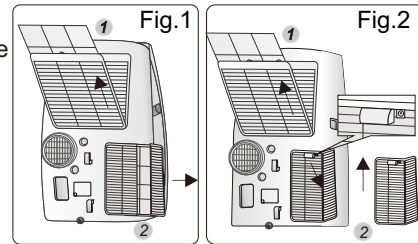

2. Clean the air filter

Use a vacuum cleaner or water to rinse filter, and if the filter is very dirty (for example, with greasy dirt), clean it with warm water (below 40°C(104°F)) with mild detergent dissolved in, and then put the filter in the shade to dry in the air.



3. Reinstall the dried filter in reverse order of removal. Put the filter cover back to its place.

Note:
if you don't use the unit for a long time,
please pull out the rubber plug to drain
the inside water out referring to right figure.

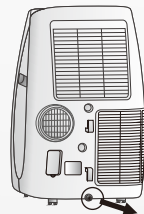

Incorrect installation or operation by not following these instructions may cause harm or damage to people, properties, etc.

The seriousness is classified by the following indications:

WARNING ⚠

This symbol indicates the possibility of death or serious injury.

CAUTION ⚠

This symbol indicates the possibility of injury or damage to properties.

WARNING ⚠

- This appliance can be used by children aged from 8 years and above and persons with reduced physical, sensory or mental capabilities or lack of experience and knowledge if they have been given supervision or instruction concerning use of the appliance in a safe way and understand the hazards involved. Children shall not play with the appliance. Cleaning and user maintenance shall not be made by children without supervision.
(Only for the AC with CE-MARKING)
- This appliance is not intended for use by persons (including children) with reduced physical, sensory or mental capabilities, or lack of experience and knowledge, unless they have been given supervision or instruction concerning use of the appliance by a person responsible for their safety. Children should be supervised to ensure that they do not play with the appliance.
(Except for the AC with CE-MARKING)
- The air conditioner must be grounded. Incomplete grounding may result in electric shocks.
Do not connect the earth wire to the gas pipeline, water pipeline, lightning rod, or telephone earth wire.
- After installment, earth leakage examination must be carried on through electrifying.
- **Don't move the unit, unless the power has been cut off and the power cord is tied to the bending and winding column.**

- **An earth leakage breaker with rated capacity must be installed to avoid possible electric shocks.**
- **Don't install air conditioner in a place where there is flammable gas or liquid.** It may cause fire.
- **If the power supply cord is damaged, it must be replaced by the manufacture or its service agent or a similar qualified person.**
- **The specification of fuse is AC250V T3.15AL.**
- **Don't put hands or any objects into the air inlets or outlets.**
It may cause personal injury or damage to the unit.
- **Don't touch the swinging wind vanes.**
It may clamp your finger and damage the driving parts of the wind vanes.
- **Don't attempt to repair the air conditioner by yourself.**
You may be hurt or cause further malfunctions.
- **In lighting storm weather, please cut off the primary power supply switch in order to prevent the machine from damage.**
- **Don't use liquid or corrosive detergent to clean the appliance and don't splash water or other liquid onto it, otherwise, it may damage the plastic components, even cause electric shock.**
- **Don't operate the unit in a wet room such as the bath room or laundry rooms.**
- **Don't touch the unit with wet or damp hands or when barefoot.**
- **If your air conditioner is not fitted with a supply cord and a plug, an all-pole switch must be installed in the fixed wiring and the distance between contacts should be no less than 3.0 mm.**

CAUTION ⚠

- Don't apply the cold air to the body for a long time. It will deteriorate your physical conditions and cause health problems.
- Don't block air inlet or air outlet, otherwise, the cooling capacity will be weakened, even cause system stop operating.
- Close the windows and doors, otherwise, the cooling capacity will be weakened.
- If the air filter is very dirty, the cooling capacity will be weakened. Please clean the air filter regularly.

- * If the unit you bought has the pump drain outlet, as shown below, please drain in this way :
Remove the pump drain plug from the back of the unit, attach the drain hose to the hole. Place the other end of the hose in the drainage way or other drain areas.

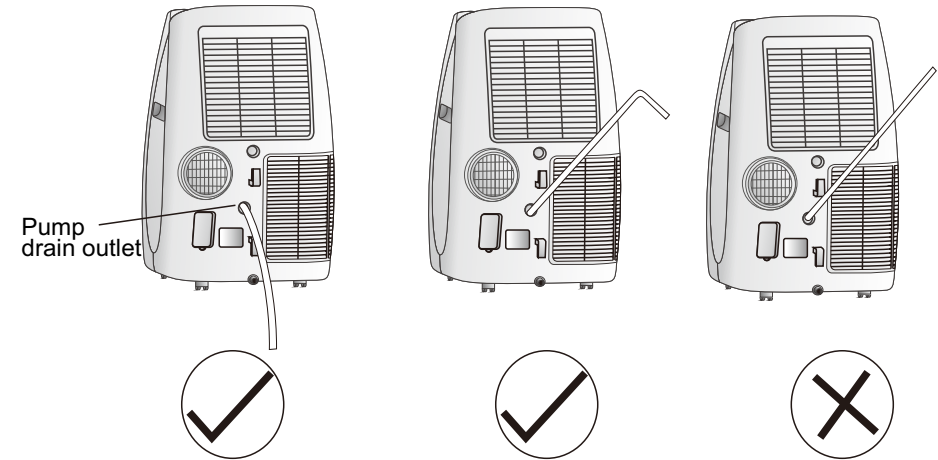

Note: Make sure the hose is secure and there are no leaks. Direct the hose toward the drain, making sure that there are no kinks that will stop the water flowing. Place the end of the hose into the drain and make sure the end of the hose is down to let the water flow smoothly. Do never let it up.

- * When the water level of the bottom tray reaches predetermined level, the digital display area shows "P1" and the WATER FULL indicator light illuminates. Carefully move the unit to a drain location, remove the bottom drain plug and let the water drain away. Reinstall the bottom drain plug and restart the machine until the P1 symbol disappears. If the error repeats, call for service.

NOTE: Be sure to reinstall the bottom drain plug before using the unit.

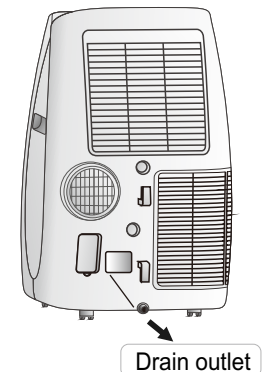

Install the exhaust duct into the wall

1. Prepare a hole in the wall. Install the wall exhaust adaptor onto the wall, be sure to fix thoroughly.
2. Attach the exhaust duct to wall exhaust adaptor.(Fig.G)

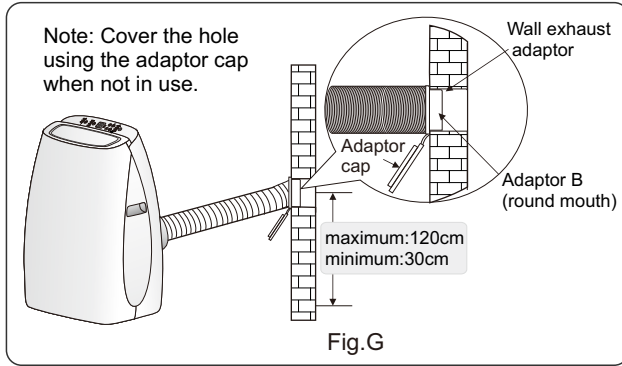

Note: 1.The duct can be compressed to 270mm minimum and extended to 1500mm maximum. It is better to keep the duct length to a minimum.
2.Stretching or bending the duct excessively will affect the cooling efficiency.
(As the following fig. Shows)

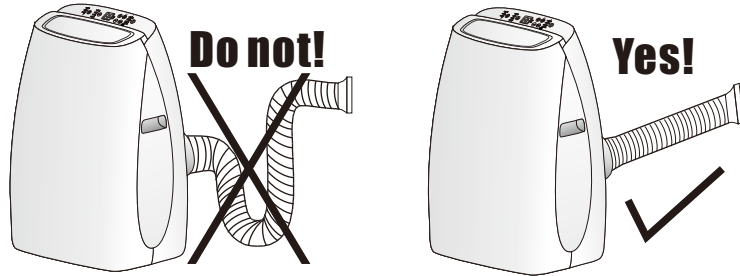

Water drainage

- * During dehumidifying mode, remove the upper drain plug from the back of the unit. Attach the drain hose to the hole. Place the other end of the hose in the drainage way or other drain areas .

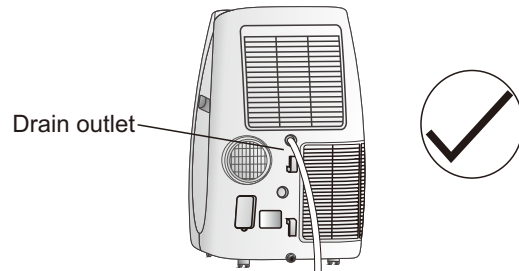

Notices for R410A models

Refrigerant leakage contributes to climate change. Refrigerant with lower global warming potential (GWP) would contribute less to global warming than a refrigerant with higher GWP, if leaked to the atmosphere. This appliance contains a refrigerant fluid with a GWP equal to [2088]. This means that if 1 kg of this refrigerant fluid would be leaked to the atmosphere, the impact on global warming would be [2088] times higher than 1 kg of CO₂ , over a period of 100 years. Never try to interfere with the refrigerant circuit yourself or disassemble the product yourself and always ask a professional.

WEEE Warning

Meaning of crossed out wheeled dustbin: Do not dispose of electrical appliances as unsorted municipal waste, use separate collection facilities.

Contact your local government for information regarding the collection systems available.

If electrical appliances are disposed of in landfills or dumps, hazardous substances can leak into the groundwater and get into the food chain, damaging your health and well-being.

When replacing old appliances with new ones, the retailer is legally obligated to take back your old appliance for disposals at least free of charge.



The oil of compressor used as below table:

Compressor Manufacturer or Trade mark	Refrigerant	The name of oil
Highly	R410A	α68HES-H or equivalent
	R22	DIAMOND MS-56 or NM56EP or equivalent
Meizhi	R410A	ESTER OIL Vg68
	R22	SUNISO 4GSD or NM56EP or equivalent
Rechi	R410A	NMOC Ze-Gles RB68EP or equivalent

FRONT VIEW

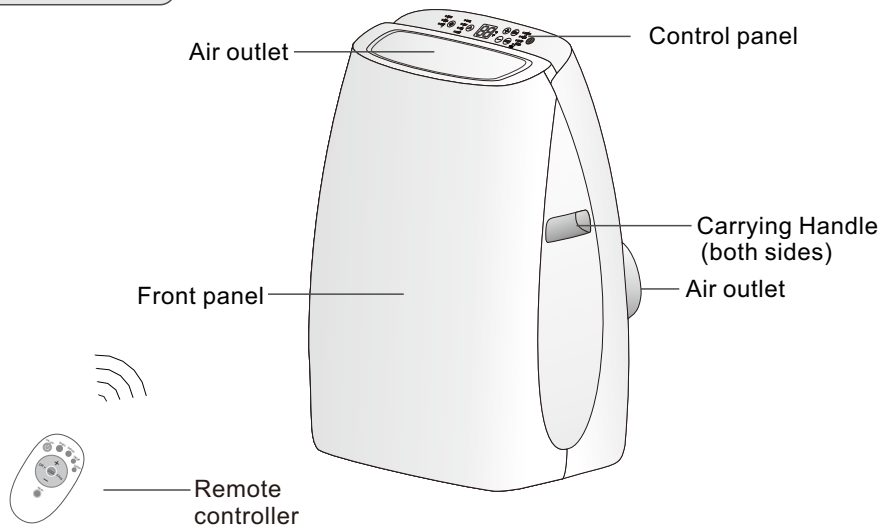

REAR VIEW

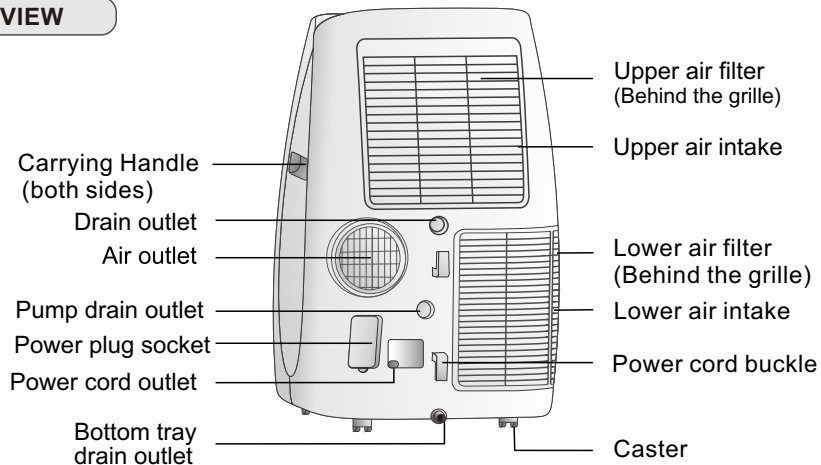

NOTE:

- * The descriptions in this user manual are text and figures may have slightly difference to the promotion information and actual appliance. Please refer to the real appliance purchased, Thank you.
- * The woking temperature range of the air conditioner is 16~35°C (60~95°F) under cooling mode; 5~27°C (41~80°F) under heating mode.

2. Connect the exhaust duct to the Air outlet connector on back of the unit. Slide-in the adaptor A downwards until it is locked in place. (Fig.C)

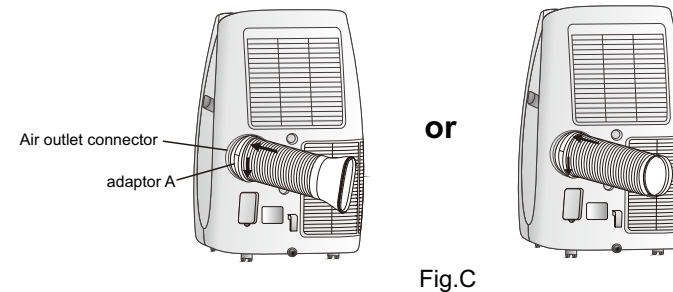

Install the exhaust duct into the window

1. Adjust the window bracket as per width or height of your window and insert the plastic pin to fix at the desired position.

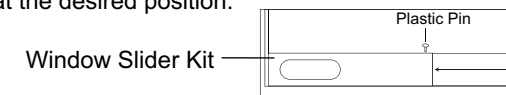

2. Install the Window Slider Kit into the window.

Your window kit has been designed to fit most standard vertical and horizontal window applications. However, it may be necessary for you to improve or modify some aspects of the installation procedure for certain types of window. Please refer to Fig. D & Fig. E for minimum and maximum window openings.

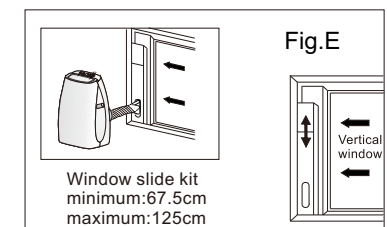
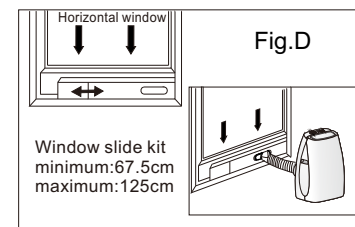

3. Remove the unit with the packed exhaust duct next to the window, and then connect the adaptorB (flat mouth) of the exhaust duct with the window.(Fig.F)

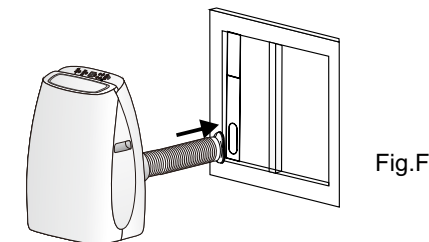

Guide of customer

- The customer should have a qualified power supply coincident with that printed on the tag of the air conditioner.
- Must use special circuit and efficient grounding outlet matching with the plug of the air conditioner.
- The appliance should be installed in accordance with national wiring regulation.
- The plug should be easily accessible after installation.

Select a best location

1. Install the mobile air conditioner in a flat and spacious location where the air outlets will not be obstructed.
2. A minimum clearance of 50cm from walls or other obstacles should be kept.
3. The gradient can't be more than 10 degrees with the horizontal plane, while putting and using the utensil.

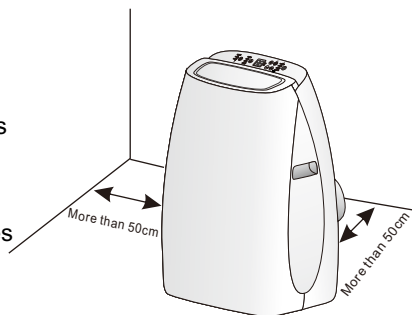

- Note:** 1. The air conditioner shall not be used in the laundry.
2. The plug shall be accessible after the unit is positioned.

Duct mount instruction

- In cooling, heating and drying mode, the exhaust duct needs to be installed while in fan mode, the exhaust duct is not needed.
- According to the actual needs, the exhaust duct can be moderately compressed and tensed, but cannot be arbitrarily stretched and bent.
- The exhaust duct can be connected with Windows or installed into the wall. Based on accessories of the unit you buy and the actual needs, you can make the installation.

1. Install the adaptor A and adaptor B (flat mouth or round mouth) onto the exhaust duct as shown in Fig.A or Fig.B .

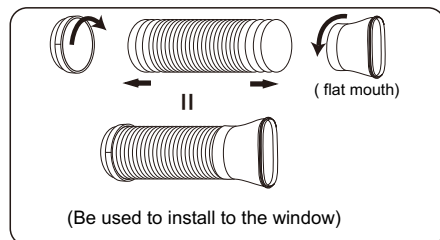

Fig.A

or

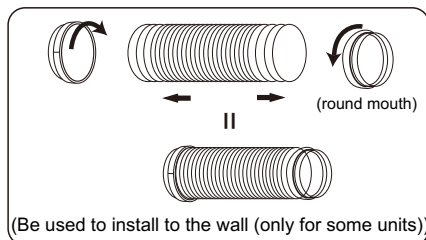
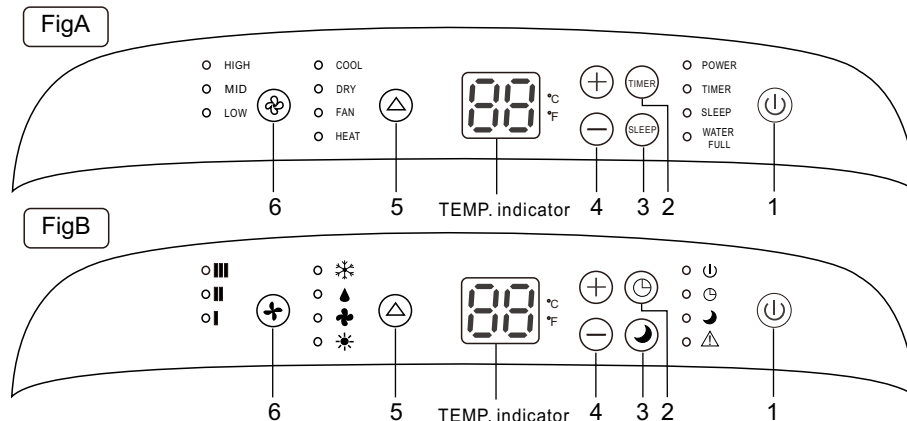

Fig.B

There are two kinds about control panel, Fig A and Fig B, the actual shape shall prevail.



TEMP. indicator

- * In cooling or heating mode, when + or - button is pressed, the setting temperature is displayed and be adjusted.
- * There are two kind of types about TEMP.indicator default display, the actual shape shall prevail.
 1. The default display is setting temperature.
 2. The default display is room temperature. After flashing 5 seconds when adjust setting temperature ,the display will revert back to room temperature.

Function buttons

1. (POWER) button — Press this button to make the unit run or stop.
2. (TIMER) / (TIMER) button — Press this button, the TIMER / (TIMER) indicator light will illuminate, then press the + or - button to set the desired time.
**Note: With the unit on, press this button to set off timer.
With the unit off, press this button to set on timer.**
3. (SLEEP) / (SLEEP) button — Press this button to enter SLEEP mode, which the unit will exit after 10 hours of continuous operation and restore to the previous status.
Note: The SLEEP function can not be activated in FAN mode.
4. (+) or (-) button
 - a. Each time the + or - button is pressed, the setting temperature will increase or decrease by 1°C (1°F). The setting temperature ranges from 16°C (60°F) ~ 32°C (90°F).
 - b. By pressing both the + and - button at the same time, the display will toggle between Celsius and Fahrenheit.
5. (MODE) button — Press this button, you can select the running mode as follows:
 [COOL → DRY → FAN → HEAT] or [❄️ → 💧 → 🌿 → ☀️]

The mode indicator light illuminates under the different mode.

Note: HEAT mode is not available for cool only units.

6.  button — Press this button, you can select the fan speed as follows:

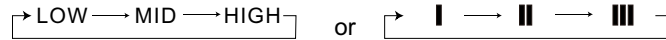

The fan speed indicator light illuminates under the different fan speed.

- NOTE:** 1. Swing function can be selected by remote controller not by control panel.
2. Other functions on control panel are as remote controller's.

Operation

WARNING

Failure to follow the below precaution could result in electrical shock, fire or personal injury.

1. The plug must be plugged into an outlet that is properly installed and grounded.
2. Do not use an extension cord or plug adaptor with this unit.

Before starting the unit

1. Select a suitable location, make sure the unit is near to an electrical outlet.
2. Install the flexible exhaust hose and the adjustable window slider kit.
3. Plug the unit into a right outlet.

Heating operation mode (Cold wind type has no heating function)

1. Press the MODE button in a sequence until the heat indicator is lighted.
2. Press the "+" and "-" button to setting your desired setting temperature.
3. Press FAN button to select the fan speed.

Cooling operation mode

1. Press the MODE button in a sequence until the cool indicator is lighted.
2. Press the "+" and "-" button to set your desired setting temperature.
3. Press FAN button to select the fan speed.

Drying operation mode



1. Press the MODE button in a sequence until the dry indicator is lighted.
2. The fan will run at a fixed speed at this operation mode.
3. Close windows and doors for the best dehumidifying effect.

Note: The setting temperature and fan speed can not be adjusted. The setting temperature is 25°C (77°F) and the fan speed is low.

Fan operation mode

1. Press MODE button in a sequence until the fan indicator is lighted.
2. Press the FAN button to select the fan speed.

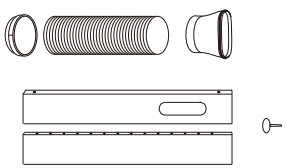
Note: The setting temperature can not be adjusted.

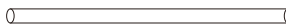
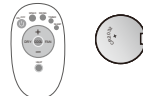
Parts	Parts name	Quantity
	Adaptor A, Exhaust duct , Adaptor B (flat mouth) , Window Slider Kit and Plastic Pin	1set
	Adaptor B (round mouth) (#) , Wall exhaust Adaptor (#)	1set
	Drain hose	1pc
	Remote controller and Battery	1pc
NOTE: Optional parts (#), some models without.		

NOTE:

All the illustrations in this manual are for explanation purpose only. Your air conditioner may be slightly different. the actual shape shall prevail.

Q models mobile air-conditioner air louver notes:

1. With automatic wind sweep function models, the air louver can not be less than automatically wind smallest outlet angle when use it.
2. No automatic sweep function models, air louver minimum opening angle: from air louver closed state breaking up 5 grid. air louver can not be less than the minimum open angle when use it.