

Owner's Manual

AUX

Split type wall mounted
air-conditioner



- ※ Please read this owner's manual carefully and thoroughly before operating the unit!
- ※ Take care of this manual for future reference.

AUX AIR CONDITIONER CO.,LTD.

1166 North Mingguang Road, Jiangshan, Yinzhou,
Ningbo, 315191 Zhejiang, China

11326001000831

Operation and maintenance

Safety Precautions	1
Notices for use	6
Names of each part	8
Clean and care	9
Troubleshooting	10

Installation service

Notices for installation	12
Install indoor unit	15
Install outdoor unit	18
Check after installation and test operation	21

Note: All the pictures in this manual are just schematic diagrams, the actual is the standard.

Check after installation

★ Electrical Safety Check

1. If the supply voltage is as required.
2. If there is any faulty or miss connection in each of the power, signal and grounding wires.
3. If the grounding wire of the air conditioner is securely grounded.

★ Installation Safety Check

1. If the installation is secure.
2. If the water drain is smooth.
3. If the wiring and piping are correctly installed.
4. Check that no foreign matter or tools are left inside the unit.

★ Leak test of the refrigerant

Depending on the installation method, the following methods may be used to check for suspect leak, on areas such as the four connections of the outdoor unit and the cores of the cut-off valves and t-valves:

1. Bubble method: Apply of spray a uniform layer of soap water over the suspected leak spot and observe carefully for bubble.
2. Instrument method: Checking for leak by pointing the probe of the leak detector according to the instruction to the suspect points of leak.

Test Operation

Test Operation preparation:

- ※Verify that all piping and connection cables are well connected.
- ※Confirm that the values at the gas side the liquid-side are fully open.
- ※Connect the power cord to an independent power socket.
- ※Install batteries in remote control.

Test Operation method:

1. Turn on the power and push the ON/OFF switch button of the remote controller to start the air conditioner.
2. Select COOL, HEAT (not available on cool-only models), SWING and other operation modes with the remote controller and see if the operation is ok.

Specific caution

1. Open front panel of the indoor.
2. The connector(as Fig) can not touch the terminal board, and is positioned as shown in Fig.

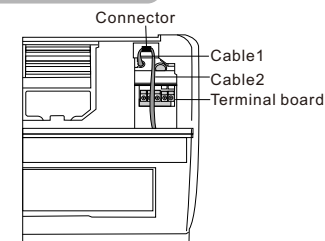

Expelling the air

★Outdoor unit refrigerant discharging method

After the pipe side connection is complete, proceed as follows.

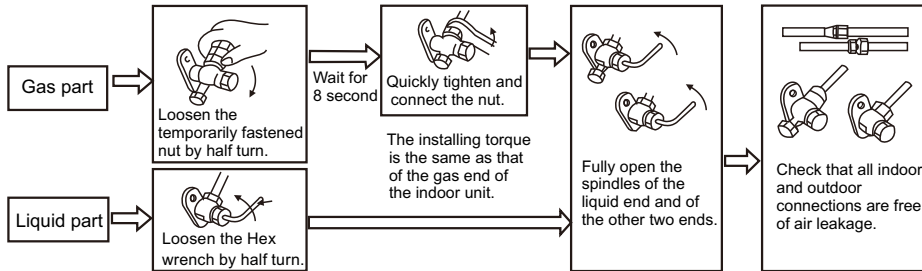

★Vacuum Pumping Method (R410A refrigerant evacuation must use the vacuum pumping method)

Before working on the air conditioner, remove the cover of the stop valve(gas and liquid valves)and be sure to retighten it afterward.(to prevent the potential air leakage)

- To prevent air leakage and spilling tighten all connecting nut of all flare tubes.
- Connect the stop valve, charge hose, manifold valve, and vacuum pump.
- Fully open the handle Lo of the manifold valve and apply vacuum for at least 15 minutes and check that the compound vacuum gauge reads -0.1MPa(-76cmHg).
- After applying vacuum, fully open the stop valve with a hex wrench.
- Check that both indoor and outdoor connections are free of air leakage.

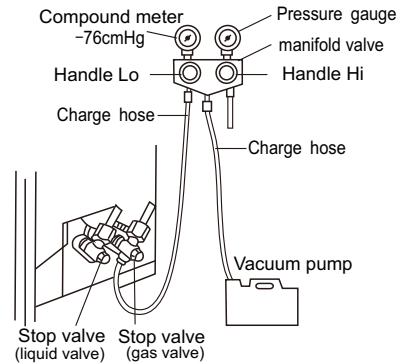

Outdoor condensation drainage(Heat pump type only)

When the unit is heating, the condensing water and defrosting water can be out reliably through the drain house.

Installation :

Install the outdoor drain elbow in $\Phi 25$ hole on the base plate, and joint the drain hose to the elbow, so that the waste water formed in the outdoor unit can be drained out to a proper plate.

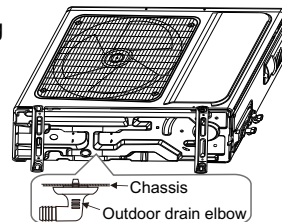

Incorrect installation or operation by not following these instructions may cause harm or damage to people, properties, etc.

The seriousness is classified by the following indications:

WARNING ⚠

This symbol indicates the possibility of death or serious injury.

CAUTION ⚠

This symbol indicates the possibility of injury or damage to properties.

WARNING ⚠

This appliance can be used by children aged from 8 years and above and persons with reduced physical, sensory or mental capabilities or lack of experience and knowledge if they have been given supervision or instruction concerning use of the appliance in a safe way and understand the hazards involved. Children shall not play with the appliance. Cleaning and user maintenance shall not be made by children without supervision.
(Only for the AC with CE-MARKING)

This appliance is not intended for use by persons (including children) with reduced physical, sensory or mental capabilities, or lack of experience and knowledge, unless they have been given supervision or instruction concerning use of the appliance by a person responsible for their safety. Children should be supervised to ensure that they do not play with the appliance.
(Except for the AC with CE-MARKING)

Safety precautions

The air conditioner must be grounded. Incomplete grounding may result in electric shocks.



Do not connect the earth wire to the gas pipeline, water pipeline, lightning rod, or telephone earth wire.

Always switch off the device and cut the power supply when the unit is not in use for long time so as to ensure safety.



Take care not let the remote control and the indoor unit watered or being too wet.

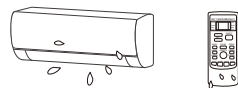

NO!

Otherwise, it may cause short circuit.

If the power supply cable is damaged, it must be replaced by the manufacture or its service agent or a similar qualified person.



Don't cut off main power switch during operating or with wet hands.



NO!

It may cause electric shock.

Don't share the socket with other electric appliance.

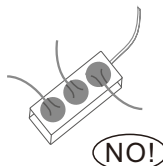

NO!

Otherwise, it may cause electric shock even fire and explosion.

Always switch off the device and cut the power supply before performing any maintenance or cleaning.



Otherwise, it may cause electric shock or damage.

Don't pull the power cable .



NO!

The damage of pulling power cord will cause serious electric shock.

An earth leakage breaker with rated capacity must be installed to avoid possible electric shocks.

Install outdoor unit

Wiring Connection

1. Loosen the screws and remove E-parts cover from the unit.
2. Connect the cables respectively to the corresponding terminals of the terminal board of the outdoor unit (see the wiring diagram), and if there are signals connected to the plug, just conduct butt joint.
3. Ground wire: Remove the grounding screw out of the electric bracket, cover the grounding wire end onto the grounding screw and screw it into the grounding hole.
4. Fix the cable reliably with fasteners (Pressing board).
5. Put the E-parts cover back in its original place and fasten it with screws.

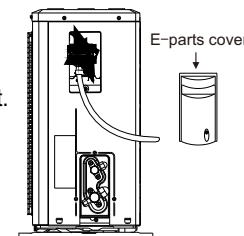

Wiring diagram

Constant speed

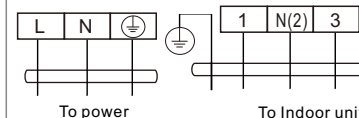

To power To Indoor unit

Variable speed

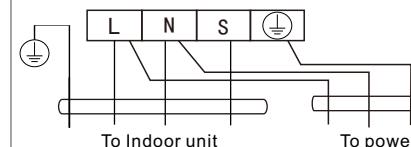

To Indoor unit To power

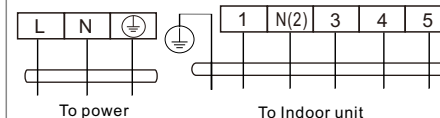

To power To Indoor unit

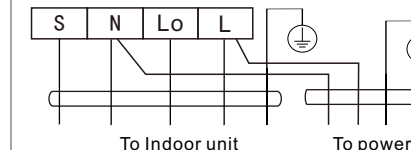

To Indoor unit To power

Connector



If there is a connector, connect it directly.

NOTE:

- ※ This manual usually includes the wiring mode for the different kind of A/C. We cannot exclude the possibility that some special type of wiring diagrams are not included .
- ※ The diagram are for reference only. If the entity is difference with this wiring diagram, please refer to the detailed wiring diagram adhered on the unit which you purchased.

Dimension drawing of outdoor unit installation

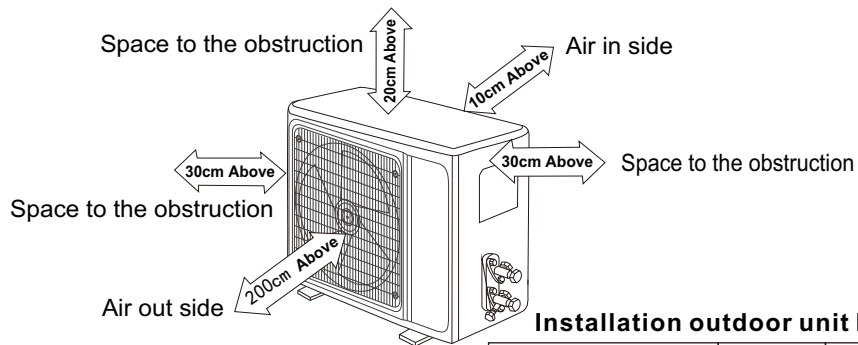

Installation outdoor unit bolt

Outdoor Unit Size of Shape W1(W2)*H*D (mm)	A (mm)	B (mm)
665(710)×420×280	430	280
600(645)×485×260	400	290
660(710)×500×240	500	260
700(745)×500×255	460	260
730(780)×545×285	540	280
760(810)×545×285	540	280
790(840)×550×290	545	300
800(860)×545×315	545	315
800(850)×590(690)×310	540	325
825(880)×655×310	540	335
900(950)×700×350	630	350
900(950)×795×330	535	350
970(1044)×803×395	675	409

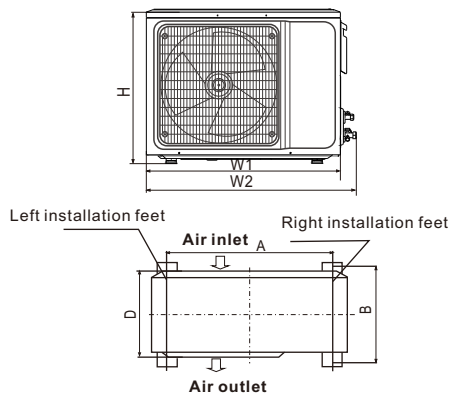

Install the connection pipe

Connect the Outdoor Unit with Connecting Pipe:
Aim the counter-bore of the connecting pipe at the stop valve, and tighten the Taper nut with fingers. Then tighten the Taper nut with a torque wrench.

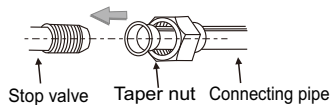

★ When prolonging the piping, extra amount of refrigerant must be added so that the operation and performance of the air conditioner will not be compromised.

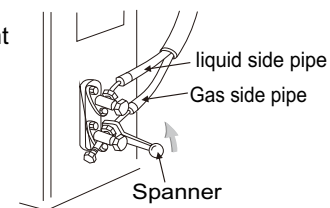

Piping length	Amount of refrigerant to be added	
≤5M	Not needed	
5-15M	CC≤12000Btu	20g/m
	CC≥18000Btu	30g/m

Note: This table is for reference only.

Don't install air conditioner in a place where there is flammable gas or liquid. The distance between them should be above 1m.

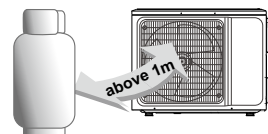

It may cause fire even explosion.

Don't use liquid or corrosive cleaning agent wipe the air conditioner and sprinkle water or other liquid either.

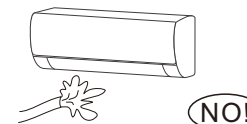

Doing this may cause electric shock or damage to the unit.

Don't attempt to repair the air conditioner by yourself.

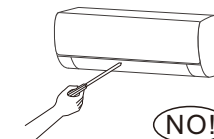

Incorrect repairs may cause fire or explosion. Contact a qualified service technician for all service requirement.

Don't use air conditioner in lightning storm weather.

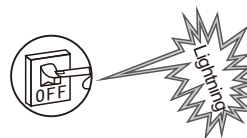

Power supply should be cut in time to prevent the occurrence of danger.

Don't put hands or any objects into the air inlets or outlets.

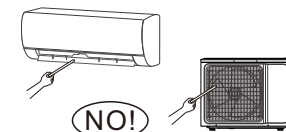

This may cause personal injury or damage to the unit.

Please note whether the installed stand is firm enough or not.

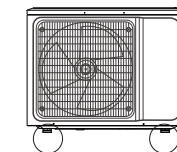

If it is damaged, it may lead to the fall of the unit and cause the injury.

Don't block air inlet or air outlet.

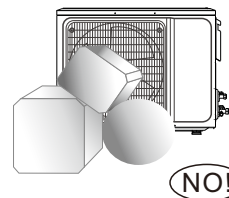

Otherwise, the cooling or heating capacity will be weakened, even cause system stop operating.

Don't let the air conditioner blow against the heater appliance.



Otherwise it will lead to incomplete combustion, thus causing poisoning.

The appliance shall be installed in accordance with national wiring regulations.

Safety Precautions

This product contains fluorinated greenhouse gases.

Refrigerant leakage contributes to climate change. Refrigerant with lower global warming potential (GWP) would contribute less to global warming than a refrigerant with higher GWP, if leaked to the atmosphere. This appliance contains a refrigerant fluid with a GWP equal to [2088]. This means that if 1 kg of this refrigerant fluid would be leaked to the atmosphere, the impact on global warming would be [2088] times higher than 1 kg of CO₂, over a period of 100 years. Never try to interfere with the refrigerant circuit yourself or disassemble the product yourself and always ask a professional.

The specification of the fuse are printed on the circuit board, such as: 3.15A/250V AC, etc.

WEEE Warning

Meaning of crossed out wheeled dustbin:
Do not dispose of electrical appliances as unsorted municipal waste, use separate collection facilities.
Contact your local government for information regarding the collection systems available.
If electrical appliances are disposed of in landfills or dumps, hazardous substances can leak into the groundwater and get into the food chain, damaging your health and well-being.
When replacing old appliances with new ones, the retailer is legally obligated to take back your old appliance for disposal at least free of charge.



Install Indoor Unit

Fixing the Indoor Unit

1. Hang the indoor unit on the peg board, and move the unit from left to right to ensure that the hook is properly positioned in the peg board.
2. Push toward the lower left side and the upper right side of the unit toward the peg board, until the hook is embedded in the slot and makes a "click" sound.

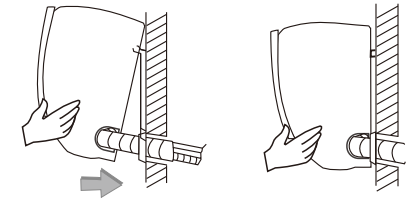

Wiring diagram

- If your air conditioner is provided with interconnection cord, the wiring of the indoor unit is connected in the factory, there is no need of connection.
- If the interconnection cord is not provided, connection is needed in accordance with the wiring diagram.

Constant speed

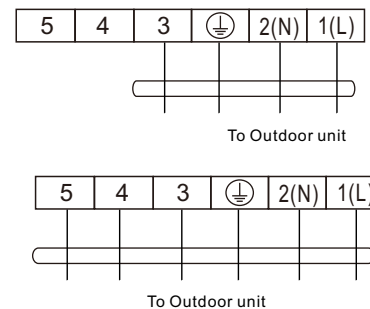

Variable speed

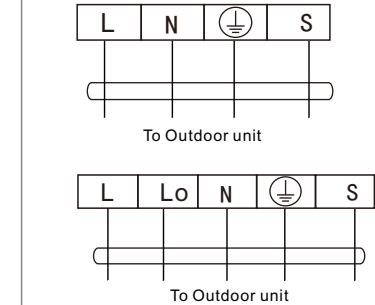

Connector



If there is a connector, connect it directly.

NOTE:

- ※ This manual usually includes the wiring mode for the different kind of A/C. We cannot exclude the possibility that some special type of wiring diagrams are not included.
- ※ The diagram are for reference only. If the entity is difference with this wiring diagram, please refer to the detailed wiring diagram adhered on the unit which you purchased.

Route of Pipeline

- Depending on the position of the unit, the piping may be routed sideway from the left or the right (Fig 1), or vertically from the back(Fig 2)(depending on the pipe length of the indoor unit). In the case of sideway routing, cut off the outlet cutting stock of the opposite side.

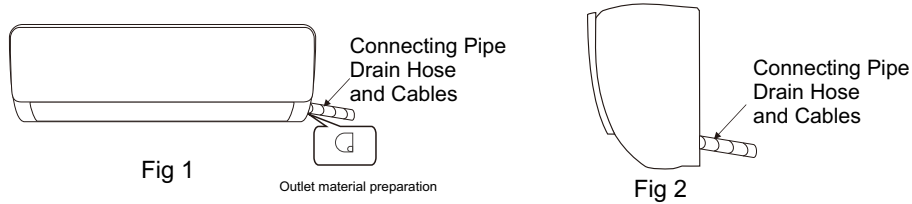

Fig 1

Fig 2

Outlet material preparation

Drain pipe connection

- Remove the mountings and pull the indoor unit pipe out of the housing.
- Connect the connecting pipe to the indoor unit:
Aim at the pipe center, tighten the Taper nut with fingers, and then tighten the Taper nut with a torque wrench, and the direction is shown in diagram on the right. The torque used is shown in the following table.

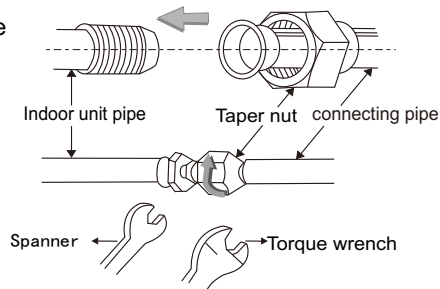

Tightening torque table

The size of pipe(mm)	Torque(N · m)
Φ6/Φ6.35	15~25
Φ9/Φ9.52	35~40
Φ12/Φ12.7	45~60
Φ15.88	73~78
Φ19.05	75~80

Wrap the Piping

- Use the insulation sleeve to wrap the joint part the indoor unit and the connection pipe, and then use insulating material to pack and seal insulation pipe, to prevent generation of condensate water on the joint part.
- Connect the water outlet with drain pipes, and make the connection pipe, cables, and the drain hose straight.
- Use plastic cable ties to wrap the connecting pipes, cables and drain hose. Run the pipe sloping downward.

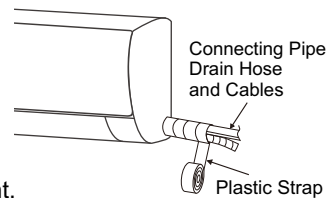

CAUTION ⚠

Don't open the windows and doors for long time when the air conditioner is running.

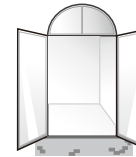

Otherwise, the cooling or heating capacity will be weakened.

Don't stand on the top of the outdoor unit or place heavy things on it.

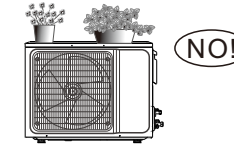

This could cause personal injuries or damage the unit.

Don't use the air conditioner for other purposes, such as drying clothes, preserving foods, etc.

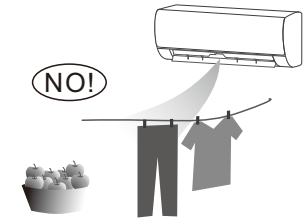

Don't apply the cold air to the body for a long time.

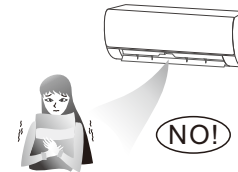

It will deteriorate your physical conditions and cause health problems.

Set the suitable temperature.

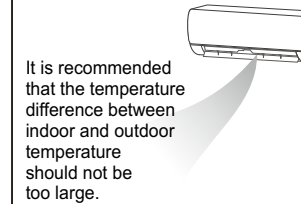

It is recommended that the temperature difference between indoor and outdoor temperature should not be too large.

Appropriate adjustments of the setting temperature can prevent the waste of electricity.

If your air conditioner is not fitted with a supply cord and a plug, an all-pole switch must be installed in the fixed wiring and the distance between contacts should be no less than 3.0 mm.

If your air conditioner is permanently connected to the fixed wiring, a residual current device (RCD) having rated residual operating current not exceeding 30 mA should be installed in the fixed wiring.

The power supply circuit should have leakage protector and air switch of which the capacity should be more than 1.5 times of the maximum current.

Regarding the installation of the air conditioners, please refer to the below paragraphs in this manual.

The conditions of unit can't normally run

* Within the temperature range provided in following table, the air conditioner may stop running and other anomalies may arise.

Cooling	Outdoor	>43°C (Apply to T1)
	Indoor	<18°C
Heating	Outdoor	>24°C
	Indoor	>27°C

- * When the temperature is too high, the air conditioner may activate the automatic protection device, so that the air conditioner could be shut down.
- * When the temperature is too low, the heat exchanger of the air conditioner may freeze, leading to water leakage or other malfunction.
- * In long-term cooling or dehumidification with a relative humidity of above 80% (doors and windows are open), there may be water condenses or dripping near the air outlet.
- * T1 and T3 refer to ISO 5151.

Notes for heating

- * The fan of the indoor unit will not start running immediately after the heating is started to avoid blowing out cool air.
- * When it is cold and wet outside, the outdoor unit will develop frost over the heat exchanger which will compromise the heating capacity. This is when the air conditioner will start defrost.
- * During defrost, the air conditioner will stop heating for about 5-12 minutes.
- * Vapor may come out from the outdoor unit during defrost. This is not a malfunction, but a result of fast defrost.
- * Heating will resume after defrost is complete.

Notes for turning off

- * When the air conditioner is turned off, the main controller will automatically decide whether to stop immediately or after running for dozens of seconds with lower frequency and lower air speed.

Dimension drawing of indoor unit installation

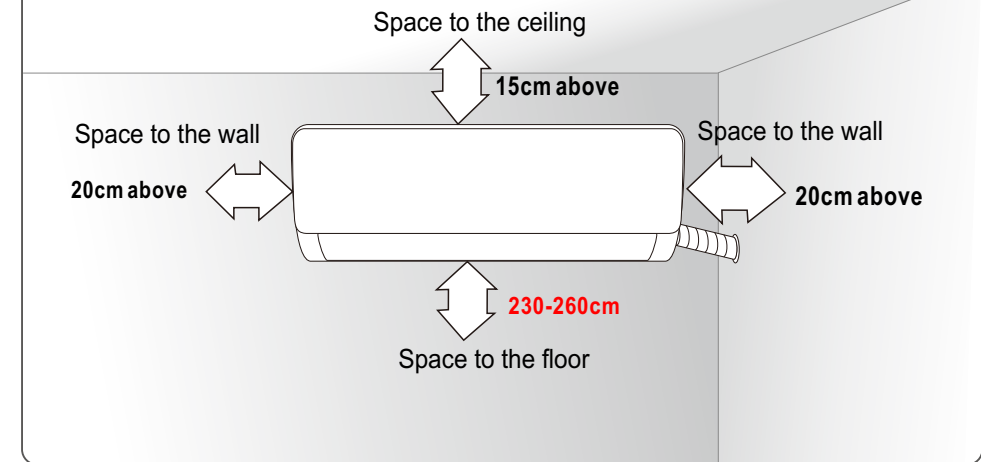

Mounting plate

1. The wall for installation of the indoor unit shall be hard and firm, so as to prevent vibration.
2. Use the "+" type screw to fasten the peg board, horizontally mount the peg board on the wall, and ensure the lateral horizontal and longitudinal vertical.
3. Pull the peg board by hand after the installation, to confirm whether it is solid.

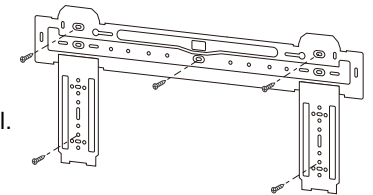

Wall-through Hole

1. Make a hole with an electric hammer or a water drill at the predetermined position on the wall for piping, which shall slant outwardly by 5°-10°.
2. To protect the piping and the cables from being damaged running through the wall, and from the rodents that may inhabit in the hollow wall, a pipe protecting ring shall be installed and sealed with putty.

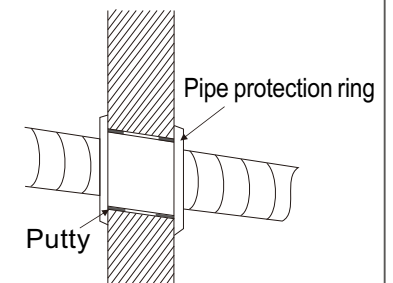

Note: Usually, the wall hole is $\Phi 60\text{mm} \sim \Phi 80\text{mm}$.
Avoid pre-buried power wire and hard wall when making the hole.

Notices for installation

Requirements for operations at raised height

- When carrying out installation at 2m or higher above the base level, safety belts must be worn and ropes of sufficient strength be securely fasten to the outdoor unit, to prevent falling that could cause personal injury or death as well as property loss.

Grounding Requirements

- The air conditioner is the type I electrical appliance and must ensure a reliable grounding.
- Do not connect the grounding wire to a gas pipe, water pipe, lightning rod, telephone line, or a circuit poorly grounded to the earth.
- The grounding wire is specially designed and shall not be used for other purpose, nor shall it be fastened with a common tapping screw.

Others

- The connection method of the air conditioner and the power cord and the interconnection method of each independent element shall be subject to the wiring diagram affixed to the machine.
- The model and rating value of the fuse shall be subject to the silkscreen on corresponding controller or fuse sleeve.

Packing list

Packing list of the indoor unit

Name	Quantity	Unit
Indoor Unit	1	Set
Remote Controller	1	PC
Batteries (7#)	2	PC
Instructions	1	Set
Drain pipe	1	PC

Packing list of the outdoor unit

Name	Quantity	Unit
Outdoor Unit	1	Set
Connecting pipe	2	PC
Plastic Strap	1	ROLL
Pipe Protection Ring	1	PC
Luting (putty)	1	PACKET

NOTE: All accessories shall be subject to actual packaging material, and if there is any difference, please understand.

Notices for use

Emergency operation

- * If the remote controller is lost or broken, use force switch button to operate the air conditioner.
- * If this button is pushed with the unit OFF, the air conditioner will operate in Auto mode.
- * If this button is pushed with the unit ON, the air conditioner will stop running.

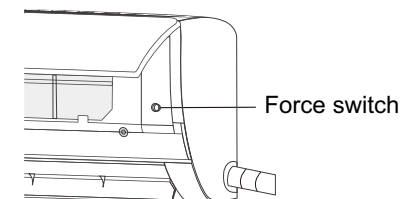

Airflow direction adjustment

1. Use up-down swing and left-right swing buttons on the remote controller to adjust the airflow direction. Refer to the operation manual of the remote controller for detail.
2. For models without left-right swing function, the fins has to be moved manually.

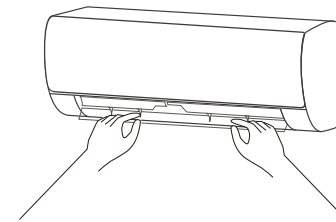

Note: Move the fins before the unit is in operation, or your finger might be injured. Never place your hand into the air inlet or outlet when the air conditioner is in operation.

ATTENTION

If the equipment emissions cannot meet the technical requirement of IEC 61000-3-3, following Attention should be take care.

Attention: This appliance can be connected only to a supply with system impedance no more than Zmax. In case necessary, please consult your supply authority for system impedance information.

Product Type	Zmax	Product Type	Zmax
ASTW-H30Q4/#-IQ	0.021	ASW-H28G5A4/#R1-C5	0.296
ASW-H28G5B4/#R1-C5	0.116	ASW-H18E1B4/#R1-C	0.296
ASW-H18E1B4/#R1-C5S	0.296		

#=LK700,LF,LH,LI,LM,LN,LR,LU,LS,LD,LP, LQ,LB,LO,LC,LE,LL,LV800,LT,LW,LZ ,ULK700,ULF,ULH,ULM,ULN,ULI,ULS,ULU,ULD,ULP,ULR, ULQ,ULB,ULO,ULC,ULE,ULL,ULV800,ULT,ULW,ULZ,QLK700,QLF,QLH,QLM,QLN,QLI,QLS,QLU,QLD,QLP,QLR,QLQ,QLB,QLO,QLC,QLE,QLL,QLV800,QLT,QLW,QLZ,DA,DB,DC,DE,DF,DH,DI

Indoor unit

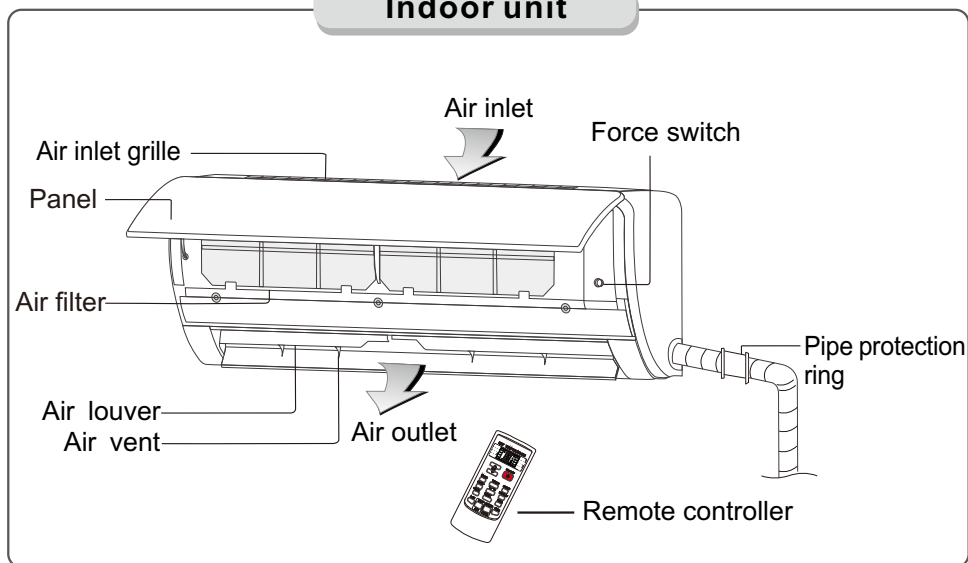

Outdoor unit

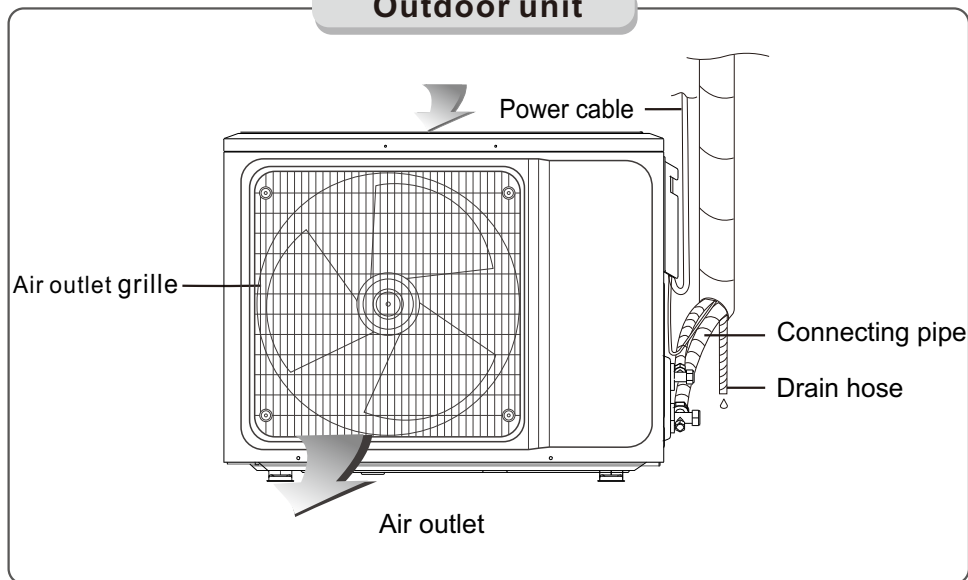

Note: All the pictures in this manual are just schematic diagrams, the actual is the standard. Plug, WIFI function, Negative-ion function, and Vertical and horizontal swing function both are optional, the actual unit shall prevail.

Electrical Safety Requirements

- Be sure to use the rated voltage and air conditioners dedicated circuit for the power supply, and the power cord diameter must meet the national requirements.
- When the maximum current of air conditioner is $\geq 16A$, it must use the air switch or leakage protection switch equipped with protection devices.
- The normal operating range is 90%-110% of the local rated voltage.
- The minimum clearance between the air conditioner and the combustibles is 1.5 m.
- The Interconnection cord connect the indoor and outdoor units. You must first choose the right cable size before preparing it for connection.
- Cable Types:
Outdoor Power Cable: H07RN-F or H05RN-F;
Interconnection cord: H07RN-F or H05RN-F;
- Minimum Cross-Sectional Area of Power Cable and interconnection cord

North America

Appliance Amps(A)	AWG
10	18
13	16
18	14
25	12
30	10
40	8

Other Regions

Rated Current of Appliance(A)	Nominal Cross-Sectional Area(mm ²)
>3 and ≤ 6	0.75
>6 and ≤ 10	1
>10 and ≤ 16	1.5
>16 and ≤ 25	2.5
>25 and ≤ 32	4
>32 and ≤ 40	6

- The size of the interconnection cord, power cable, fuse, and switch needed is determined by the maximum current of the unit. The maximum current is indicated on the nameplate located on the side panel of the unit. Refer to this nameplate to choose the right cable, fuse, or switch.
- Note: Core number of cable refer to the detailed wiring diagram adhered on the unit which you purchased.

Important Notices

- Before installing, please contact with local authorized maintenance center, if unit is not installed by the authorized maintenance center, the malfunction may not solved, due to discommodious contact.
- The air conditioner must be installed by professionals according to the national wiring rules and this manual.
- To move and install air conditioner to another place, please contact our local special service center.

Requirements For Installation Position

- Avoid places of inflammable or explosive gas leakage or where there are strongly aggressive gases.
- Avoid places subject to strong artificial electric/magnetic fields.
- Avoid places subject to noise and resonance.
- Avoid severe natural conditions (e.g. heavy lampblack, strong sandy wind, direct sunshine or high temperature heat sources).
- Avoid places within the reach of children.
- Shorten the connection between the indoor and outdoor units.
- Select where it is easy to perform service and repair and where the ventilation good.
- The outdoor unit shall not be installed in any way that could occupy an aisle, stairway, exit, fire escape, catwalk or any other public area.
- The outdoor unit shall be installed as far as possible from the doors and windows of the neighbors as well as the green plants.

Requirements of the mounting structure

- The mounting rack must meet the relevant national or industrial standards in terms of strength with welding and connection areas rustproofed.
- The mounting rack and its load carry surface shall be able to withstand 4 times or above the weight of the unit, or 200kg, whichever is heavier.
- The mounting rack of the outdoor unit shall be fastened with expansion bolt.
- Ensure the secure installation regardless of what type of wall on which it is installed, to prevent potential dropping that could hurt people.

Warning

- Before the cleaning of the air conditioner, it must be shut down and the electricity must be cut off for more than 5 minutes, otherwise there might be the risk of electric shocks.
- Do not wet the air conditioner, which can cause an electric shock. Make sure not to rinse the air conditioner with water under any circumstances.
- Volatile liquids such as thinner or gasoline will damage the air conditioner housing, therefore please clean the housing of air conditioner only with soft dry cloth and damp cloth moistened with neutral detergent.
- In the course of the using, pay attention to cleaning the filter regularly, to prevent the covering of dust which may affect the effect. If the service environment of the air conditioner is dusty, correspondingly increase the number of times of cleaning. After removing the filter, do not touch the fin part of the indoor unit with the finger, so as to avoid scratching it.

Clean the panel

When the panel of the indoor unit is contaminated, clean it gently with a wrung towel using tepid water below 45°C, and do not remove the panel while cleaning.

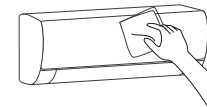

Clean the air filter

Remove the air filter

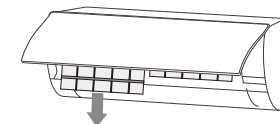
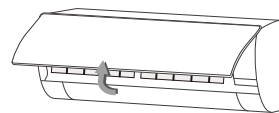

1. Use both hands to open the panel for an angle from both ends of the panel in accordance with the direction of the arrow.
2. Release the air filter from the slot and remove it.

Clean the Air Filter

Use a vacuum cleaner or water to rinse filter, and if the filter is very dirty (for example, with greasy dirt), clean it with warm water (below 45°C) with mild detergent dissolved in, and then put the filter in the shade to dry in the air.



Clean the air filter

■ Mount the Filter

1. Reinstall the dried filter in reverse order of removal, then cover and lock the panel.



Check before use

1. Check whether all the air inlets and outlets of the units are unblocked.
2. Check whether there is blocking in the water outlet of the drain pipe, and immediately clean it up if any.
3. Check the ground wire is reliably grounded.
4. Check whether the remote control batteries are installed, and whether the power is sufficient.
5. Check whether there is damage in the mounting bracket of the outdoor unit, and if any, please contact our local service center.

Maintain after use

1. Cut off the power source of the air conditioner, turn off the circuit breaker and remove the batteries from the remote control.
2. Clean the filter and the unit body.
3. Remove the dust and debris from the outdoor unit.
4. Check whether there is damage in the mounting bracket of the outdoor unit, and if any, please contact our local service center.

Troubleshooting

⚠ Caution

* Do not repair the air conditioner by yourself as wrong maintenance may cause electric shock or fire, please contact the authorized service center and let the professionals conduct the maintenance, and checking the following items prior to contacting for maintenance can save your time and money.

Phenomenon

Troubleshooting

Air conditioner can not operate at all.

- Has the power been shut down?
- Is the wiring loose?
- Is voltage too high or too low ?(measured by professionals)
- Does it reach the set time for start up?
- Does the circuit protection device trip?

Remote controller is not available.

- Is the remote controller out of effective distance to the indoor unit?
- Are there any obstructions between the controller and the signal receptor?
- Is the battery exhausted?

Cooling (Heating) efficiency is not good.

- Is the setting temperature suitable?
- Are air filter dirty?
- Is the air inlet or outlet obstructed?
- Is indoor fan speed set at low speed?
- Is there any heat source in your room?

Indoor unit does not operate immediately when the air conditioner is restarted.

If the air conditioner is turned on immediately after it is turned off, the protective delay switch will delay the operation for 3 to 5 minutes.

There is unusual smell blowing from the outlet after operation is started.

The air conditioner itself does not have undesirable odor. If there is odor, it may be due to accumulation of the odor in the environment. Please clean the air filter or activate the cleaning function.

There is sound of running water during the running of air conditioner.

Sometimes the "hissing" sound of running water can be heard. This is the sound of the flow of the refrigerant, not a malfunction.

A slight "click" sound is heard at the of start-up or shut-down.

Due to temperature changes, panel and other parts will swell, causing the sound of friction. This is normal, not a fault.

During the cooling operation, the indoor unit outlet sometimes will blow out mist.

This is because the indoor air is cooled rapidly. After it runs for some time, the indoor temperature and humidity will be reduced and the mist will disappear.

⚠ **Immediately stop all operations and cut off the power supply , contact our Service center locally in following situations.**

- ▲ Shriill sound is heard or Unpleasant odor is emitted during the operation.
- ▲ There is an abnormal heat in power supply cord and power plug.
- ▲ Accidentally pour impurities or water into the machine or the remote control.
- ▲ Air switch or protection switch often breaks.